

SpotArm™ Type Blood Pressure Monitor Model i-Q132

- **Instruction Manual**
- **Mode d'emploi**
- **Gebrauchsanweisung**
- **Manuale di istruzioni**
- **Manual de instrucciones**
- **Gebruiksaanwijzing**
- **РУКОВОДСТВО ПО ЭКСПЛУАТАЦИИ**

EN

FR

DE

IT

ES

NL

RU

AR



• **كتيب الإرشادات**

All for Healthcare

Contents

Before using the unit

Introduction	3
Important Safety Information	4
1. Overview	7
2. Preparation	10
2.1 Installing/Replacing the Batteries	10
2.2 Connecting the AC Adapter	13
2.3 Setting the Date and Time	14

Operating instructions

3. Using the Unit	19
3.1 How to Sit Correctly When Taking a Measurement.....	19
3.2 Place Your Arm Through the Arm Cuff.....	21
3.3 Taking a Reading.....	23
3.4 Instructions for Special Conditions	31
3.5 Using the Memory Function.....	32

Care and maintenance

4. Handling Errors and Problems	39
4.1 Error Messages	39
4.2 Troubleshooting.....	41
5. Maintenance and Storage	44
6. Technical Data	46
7. Some Useful Information about Blood Pressure	48

Introduction

Thank you for purchasing the OMRON i-Q132 Intellisense SpotArm™ Type Upper Arm Blood Pressure Monitor.

The OMRON i-Q132 Intellisense is a fully automatic blood pressure monitor, operating on the oscillometric principle. It measures your blood pressure and pulse rate simply and quickly. For comfortable controlled inflation without the need for pressure pre-setting or re-inflation the device uses its advanced “Intellisense” technology.

The adjustable cuff angle corrects the body posture which tends to be stooped. The elbow rest stabilizes the position and keeps the arm at the most appropriate angle.

By simply placing the arm through the cuff, it automatically wraps around your arm to the appropriate size and starts to measure your blood pressure and pulse rate.

The monitor stores measurement results for two people and features morning and evening averages.

 **Please read this instruction manual thoroughly before using the unit. For specific information about your own blood pressure, CONSULT YOUR DOCTOR.**

Important Safety Information

Consult your doctor during pregnancy, arrhythmia and arteriosclerosis. Please read this section carefully before using the unit.

Warning:

Indicates a potentially hazardous situation which, if not avoided, could result in death or serious injury.

(General Usage)

- Always consult your doctor. Self-diagnosis of measurement results and self-treatment are dangerous.
- People with severe blood flow problems, or blood disorders, should consult a doctor before using the unit. Cuff inflation can cause internal bleeding.

(AC Adapter Usage)

- Never plug in or unplug the power cord from the electric outlet with wet hands.

(Battery Usage)

- If battery fluid should get in your eyes, immediately rinse with plenty of clean water. Consult a doctor immediately.

Caution:

Indicates a potentially hazardous situation which, if not avoided, may result in minor or moderate injury to the user or patient or damage to the equipment or other property.

(General Usage)

- Do not leave the unit unattended with infants or persons who cannot express their consent.
- Do not use the unit for any purpose other than measuring blood pressure.
- Do not disassemble the unit.

- Do not inflate the arm cuff over 299 mmHg.
- If the cuff does not stop inflating, or some other abnormality occurs, press the Emergency Deflation Switch immediately to prevent from internal bleeding or damage to peripheral nerves.
- To inflate the cuff manually, refer to Chapter 3.4. If the cuff is over inflated, it can cause internal bleeding.
- Be sure to remove watches and other jewelry (rings, bracelets) etc. that could damage the cuff lining during application.
- Do not take readings if the cuff lining is damaged. This could cause injury.
- Do not use a mobile phone near the unit. This could cause a malfunction.

(AC Adapter Usage)

- Use only the original AC adapter designed for this unit. Use of unsupported adapters may damage and/or may be hazardous to the unit.
- Plug the AC adapter into the appropriate voltage outlet.
- Do not use the AC adapter if the unit or the power cord is damaged. Turn off the power and unplug the power cord immediately.

(Battery Usage)

- If battery fluid should get on your skin or clothing, immediately rinse with plenty of clean water.
- Use only four “AA” alkaline batteries with this unit. Do not use other types of batteries.
- Do not insert the batteries with their polarities incorrectly aligned.
- Replace old batteries with new ones immediately. Replace all four batteries at the same time.
- Remove the batteries if the unit will not be used for three months or more.
- If the batteries have been removed for more than 30 seconds, the date and time setting will need to be reset.
- Do not use new and used batteries together.

General Precautions

- Do not apply strong shocks and vibrations to or drop the unit.
- Do not take measurements after bathing, drinking alcohol, smoking, exercising or eating.
- Read and follow the “Important information regarding Electro Magnetic Compatibility (EMC)” in the Technical Data Section.
- Read and follow the “Correct Disposal of This Product” in the Technical Data Section when disposing of the device and any used accessories or optional parts.
- When the unit is not in use, or if it is moved etc., do not place objects (writing implements, note books, the AC adapter etc.) in the arm cuff. This could cause damage to the cuff lining or the unit and prevent the unit from taking correct readings.
- Do not inflate the arm cuff if your arm is not in place.
- Do not take readings if your arm is placed incorrectly (upside down or from the opposite side of the unit).
- Do not move the unit unless the arm cuff has been secured.

1. Overview

Main Unit

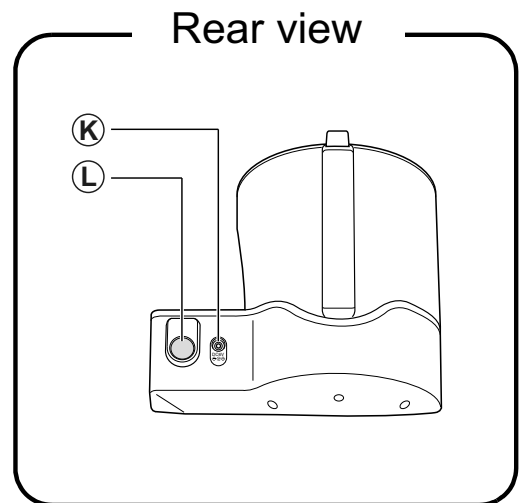
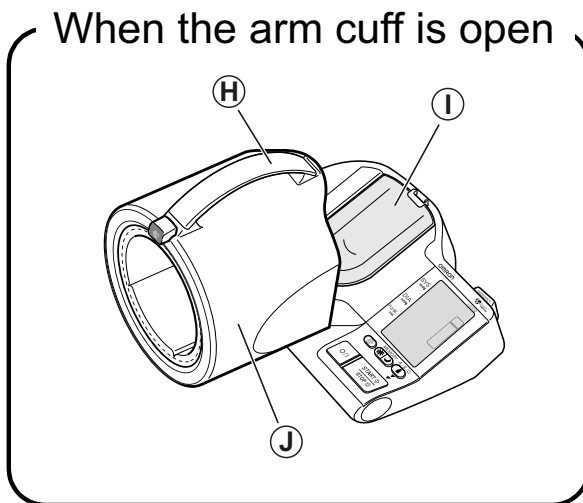
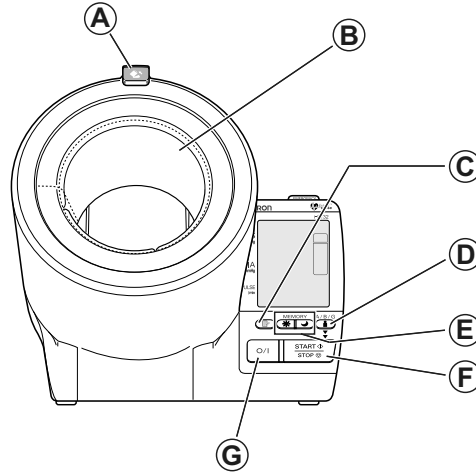

- A. Arm cuff release button
Press this to open as shown above.
- B. Cuff lining
- C. MEMORY button
- D. User ID selection button
- E. Weekly average (Morning ☀ / Evening 🌙) button
- F. START/STOP button
- G. O/I button (Power switch)
- H. Handle

- I. Elbow rest
- J. Arm cuff
- K. AC adapter jack
- L. Emergency deflation switch
Press this to stop measurement in an emergency.

EN

Display

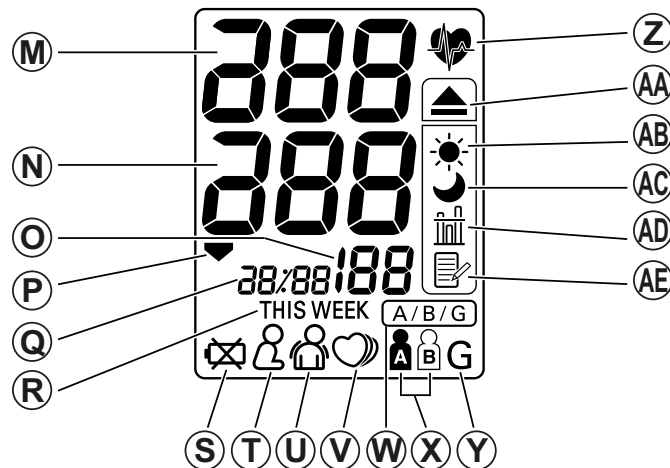

- M. Systolic blood pressure
- N. Diastolic blood pressure
- O. Pulse display
- P. Deflation symbol
- Q. Date/Time display
- R. Week display
- S. Battery low symbol
- T. Posture symbol
Displayed when sitting incorrectly.
- U. Movement symbol
Displayed if you move your body during the measurement.
- V. Irregular heartbeat symbol
- W. User select symbol
Indicates to select the user I.D. or guest.
- X. User ID symbol (A or B)
Indicates user A or user B as selected by the user to take a measurement or when using the memory function.
- Y. Guest symbol
- Z. Heartbeat symbol
 1. Flashes during measurement.
 2. If flashing after measurement completed, or when viewing results stored in the memory, indicates blood pressure out of recommended range*.
- AA. Morning hypertension symbol
Indicates blood pressure out of recommended range*.
- AB. Morning average symbol
Displayed when viewing morning averages using the memory function.
- AC. Evening average symbol
Displayed when viewing evening averages using the memory function.
- AD. Average value symbol
Displayed when viewing value for the last three measurements.
- AE. Memory symbol
Displayed when viewing values stored in the memory.

* **Note:** If your systolic or diastolic pressure is outside the standard range (above 135/85 mmHg) the Heartbeat symbol as well as the Morning hypertension symbol will blink. Please refer to Chapter 3.3.8.

Package Contents

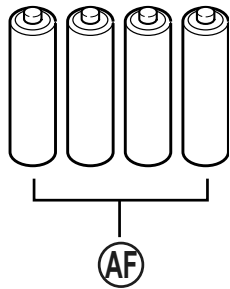

AF. Four “AA” alkaline (LR6)
batteries

AG. AC adapter

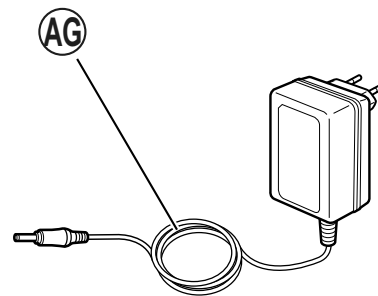

- Instruction manual
- Quick guide
- Guarantee card
- Blood pressure pass

2. Preparation

2.1 Installing/Replacing the Batteries

To set the date and time, first insert the batteries, then attach the AC adapter.

- Please insert the batteries even if you will be using the AC adapter. The batteries are required to store the date and time setting. If the unit is used without the batteries inserted, the clock will stop when the AC adapter is disconnected. However, the measurement values remain in the memory.
- If you use the AC adapter to power the unit, the backlight of the display will light, making the display easier to see. The backlight will not light when using batteries only.
- By using both the AC adapter and batteries, the batteries will last longer.

Installing the Batteries

1. Make sure that the arm cuff is secured to the unit, and turn the unit upside down.
2. Slide the battery cover in the direction of the arrow while pressing the ribbed part of the cover.

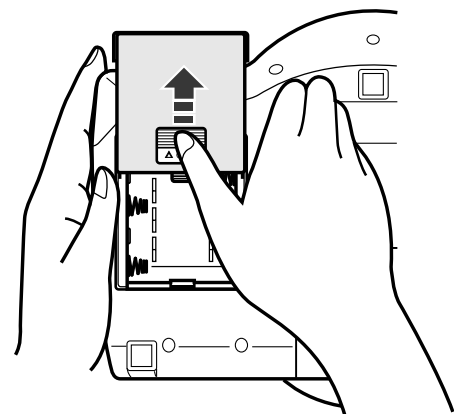

3. Install or replace four “AA” size batteries so that the + (positive) and - (negative) polarities match the polarities indicated in the battery compartment.

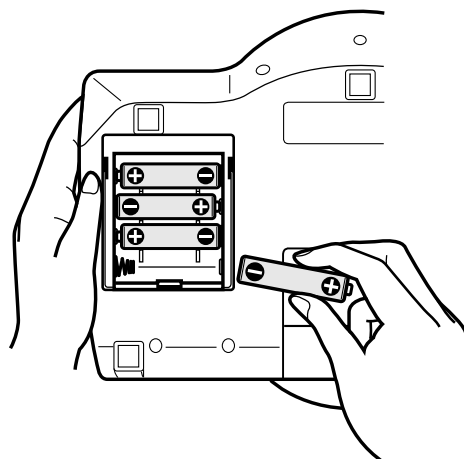

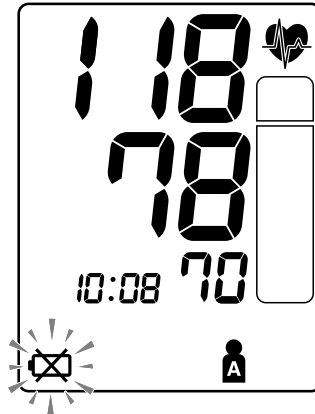

4. Put the battery cover back in place.
Slide the battery cover, until it clicks into place.

Battery Life & Replacement



If the battery low symbol () appears on the display, replace all four batteries at the same time.

- When the battery low symbol () starts to blink, you will still be able to use the unit for a short while. You should replace the batteries with new ones ahead of time.
- When the symbol () remains lit, the batteries are exhausted. You should replace the batteries with new ones at once. Turn the unit off before replacing the batteries.
- Remove the batteries if the unit will not be used for three months or more.
- If the batteries have been removed for more than 30 seconds, the Date/Time setting will need to be reset. See Chapter 2.3 for details.
- Dispose of batteries according to applicable local regulations.

Four new “AA” alkaline batteries will last for approximately 250 measurements, when used to take six measurements a day using battery power only.

Since the supplied batteries are for monitoring use only, they may have a shorter life and not last for 250 measurements.

2.2 Connecting the AC Adapter

Note: Use only the AC adapter designed for this unit.

1. Insert the plug of the AC adapter into the AC adapter jack on the back of the unit.
2. Insert the power plug of the AC adapter into a power outlet.

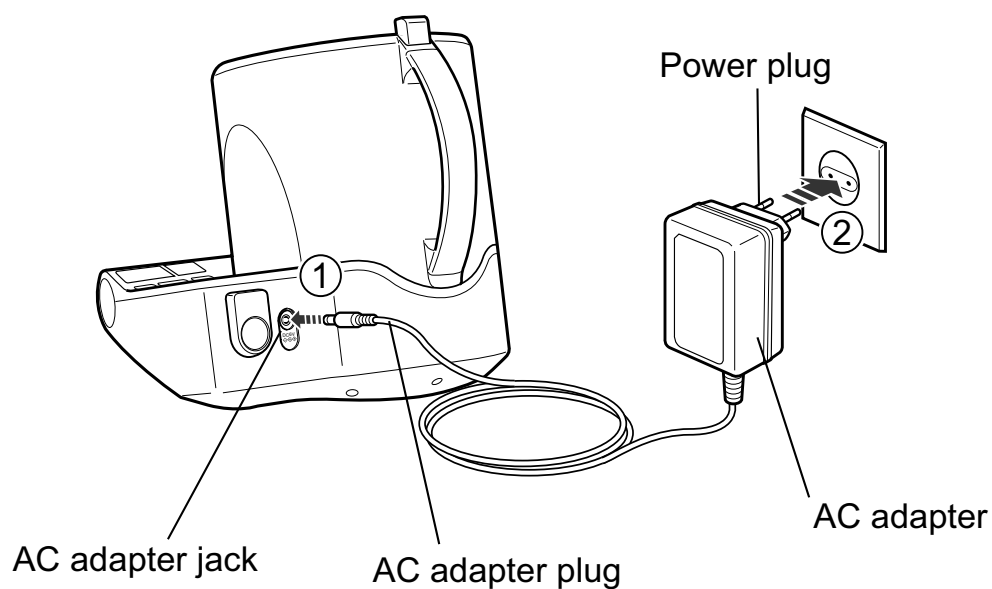

2.3 Setting the Date and Time

Your blood pressure monitor automatically stores up to 84 individual measurement values with the date and time for each user.

To make use of the memory and average values functions:



- Set the unit to the correct date and time before taking a measurement for the first time.
- If the batteries have been removed for more than 30 seconds, the Date/Time setting will need to be reset.

Set the year, month, day, hours and minutes for the current date and time.

(For details on changing the date and time setting, refer to “Adjusting the Date and Time Setting”.)

The weekly average buttons are used to set the date and time.

Use the buttons as described below to adjust the date and time setting.

-  Evening average button: Press this button to increase the value for the date/time setting.
-  Morning average button: Press this button to decrease the value for the date/time setting.



1. Press the O/I button to turn the power on. All items on the display will appear briefly, then the year digit will flash.

Note:

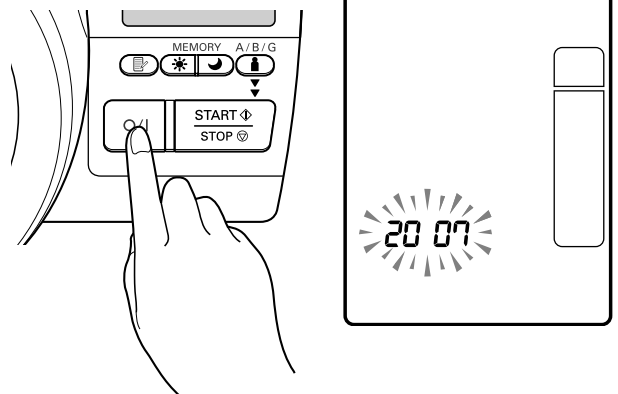
- The illustration to the right shows the display when the unit is used for the first time, after the clock has stopped or after replacing the batteries.



2. Press the weekly average buttons to adjust the year setting.

- Press the Evening average button  once to increase the setting by one year.
- Press the Morning average button  once to decrease the setting by one year.
- Hold the buttons down to increase (decrease) the digits rapidly.

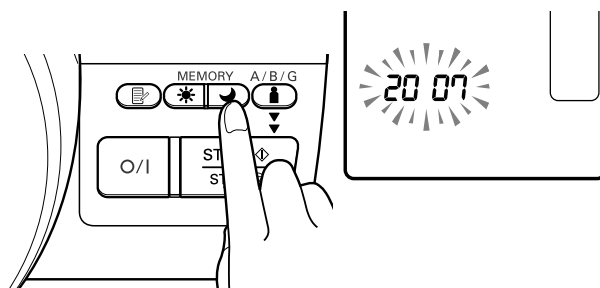

Note: The range for the year setting is 2007 to 2030. If the year reaches 2030, it will return to 2007.

3. Press the MEMORY button to confirm the setting when the desired number appears on the display.

The year is set and the month digits flash on the display.

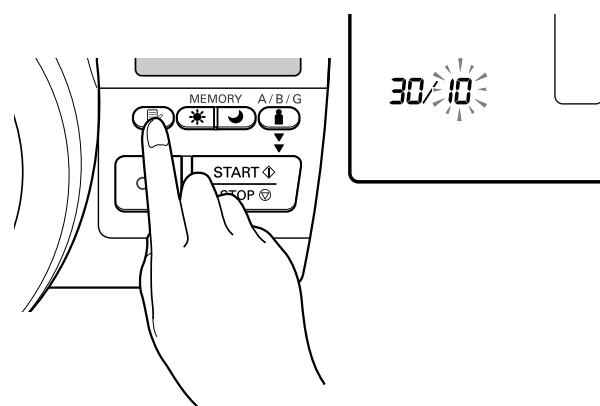

4. Press the weekly average buttons to adjust the month setting.

- Press the Evening average button once to increase the setting by one month.
Press the Morning average button once to decrease the setting by one month.
- Hold the buttons down to increase (decrease) the digits rapidly.

- 5.** Press the MEMORY button to confirm the setting when the desired number appears on the display.

The month is set and the day digits flash on the display.

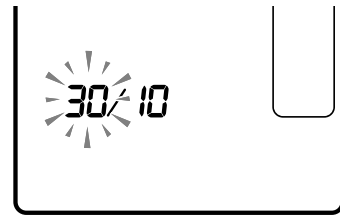

Example: when October has been set as the month.

- 6.** Press the weekly average buttons to adjust the day setting.
- Press the Evening average button once to increase the setting by one day.
Press the Morning average button once to decrease the setting by one day.
 - Hold the buttons down to increase (decrease) the digits rapidly.

- 7.** Press the MEMORY button to confirm the setting when the desired number appears on the display.

The day is set and the hour digits flash on the display.

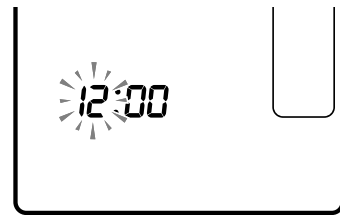

-
8. Set the hour and minutes in the same way as the date settings.

Press the weekly average buttons to adjust the digits for the hour and minutes, then press the MEMORY button to confirm the setting.

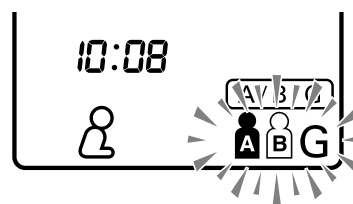

When the date and time settings have been set, the display changes to that shown to the above.

-
9. Press the O/I button to turn the power off.

Note: You can also start taking readings immediately, rather than turn the unit off.

Adjusting the Date and Time Setting

Note: If you need to change the date and time for some reason, or if the date and time has been reset after replacing the batteries, adjust the date and time between 10:00 and 18:59. This will avoid problems with morning and evening weekly averages stored in the memory.

1. Press the O/I button to turn the power off.

2. Turn the unit on then press and hold the MEMORY button for three seconds or longer when the standby display (shown right) appears.

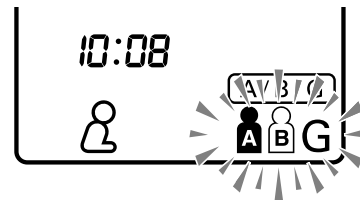

Standby display
(When the arm cuff is closed.)

3. The year setting flashes on the display.

Refer to Chapter 2.3 to adjust the settings for the date and time.



3. Using the Unit

3.1 How to Sit Correctly When Taking a Measurement

Correct posture during measurement is necessary to get accurate results.

Notes:

- Measurements should be taken in a quiet place and you should be in a relaxed, seated position. Make sure that the room is not too hot or too cold.
- Avoid eating, drinking alcohol, smoking, or exercising for at least 30 minutes before taking a measurement.
- Do not move or talk during measurement.

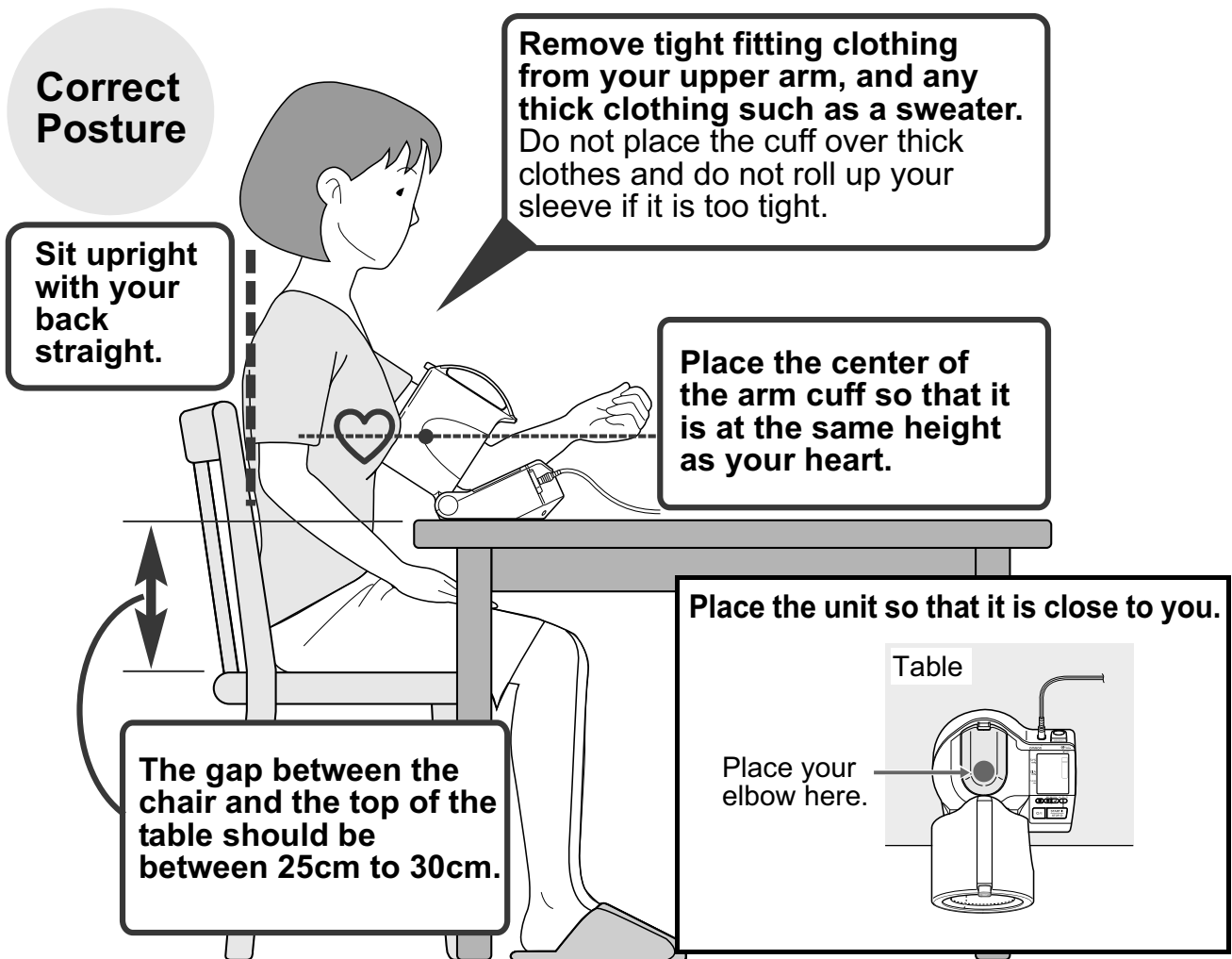

Note: You can take a measurement on either your left or right arm. The blood pressure can differ between the right arm and the left arm and therefore also the measured blood pressure values can be different. Omron recommends to always use the same arm for measurement. If the values between the two arms differ substantially, please check with your physician which arm to use for your measurement.

Incorrect Posture

If you are leaning forwards, this can put pressure on your stomach, which could cause the measurement results to be incorrect. Readings cannot be taken correctly in the following cases.

- **Arched back (leaning forwards)**
- **Sitting cross-legged**
- **Sitting on a sofa or at a low table so that you tend to lean forward**

If the unit is too far away from your body.



If the unit is at a level lower than your heart.



3.2 Place Your Arm Through the Arm Cuff

Remove the cushion sheet before using the unit for the first time.

Take readings with your bare arm or light clothing.

Note: Remove thick clothing from your upper arm. Do not take readings over thick clothes or rolled-up sleeves.

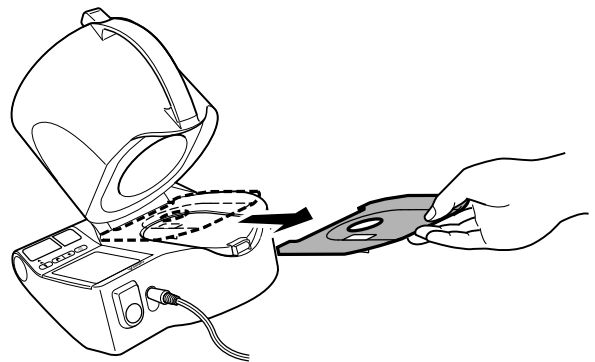

1. Press the Arm cuff release button to open the arm cuff.

Arm cuff release button



The arm cuff can be moved within the range shown to the right.

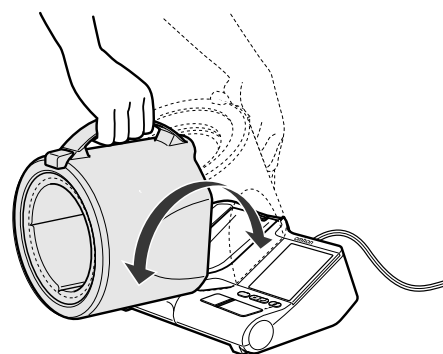

2. Place your left arm through the arm cuff.

Notes:

- Do not remove the cuff lining in the arm cuff.
- If the cuff lining becomes detached, contact your OMRON distributor or Customer Services as mentioned on the package.

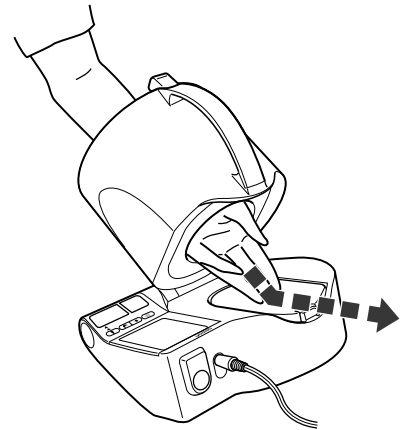

3. Place your elbow on the elbow rest.

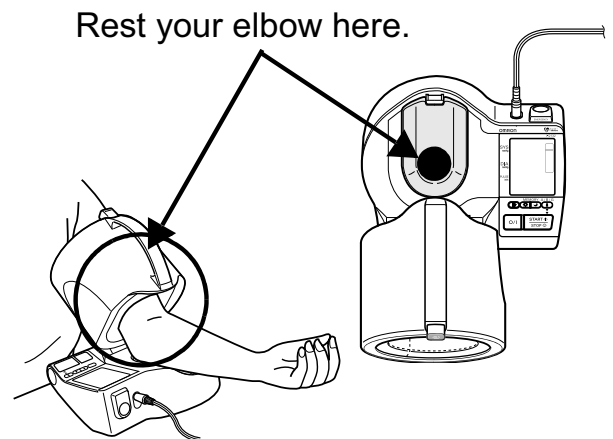

Taking measurements on the right arm

Refer to steps 2 and 3 above, and place your right arm through the arm cuff as shown.

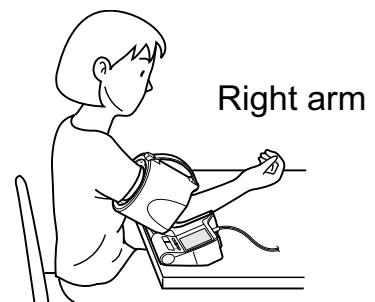

4. Check that you are sitting correctly.
(Refer to Chapter 3.1.)

3.3 Taking a Reading

Try to take readings at the same time each day (within 1 hour after waking up is recommended). This will make the results more useful.

Note: If your systolic blood pressure is known to be above 170 mmHg, refer to Chapter 3.4.

1. Sit comfortably and relax.

If you feel tense, take a few deep breaths.

2. Press the O/I button to turn the power on.

The unit is turned on and the display appears as shown below.

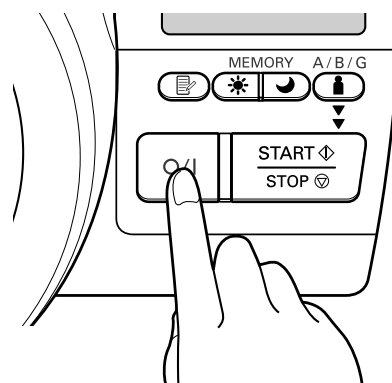
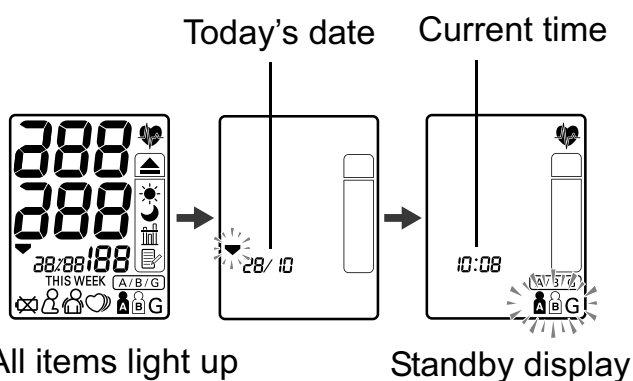

3. Press the user ID selection button to select the desired user.

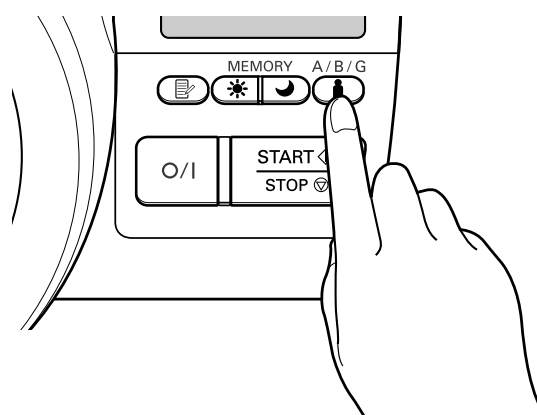

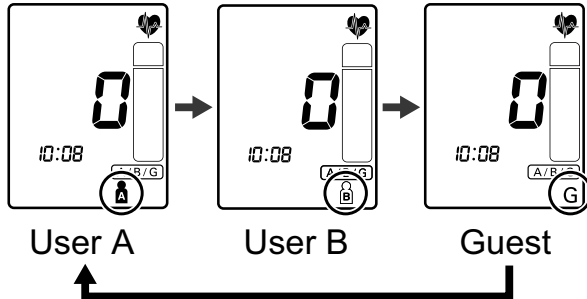

The user alternates with each press of the user ID selection button, as shown below.



Note:

- If “G” is selected, the measurement results are not stored in the memory.
- If the START/STOP button is pressed without selecting a user ID, “G” is displayed and the measurement results are not stored in the memory.

4. Check that you are sitting correctly.

If you are not sitting correctly, the  symbol appears on the display. The  symbol disappears when you are in the correct posture.

Start measurement only after checking that you are sitting correctly.

Note: Depending on the angle of the arm cuff, the  symbol will appear on the display even if your arm is not in the arm cuff.

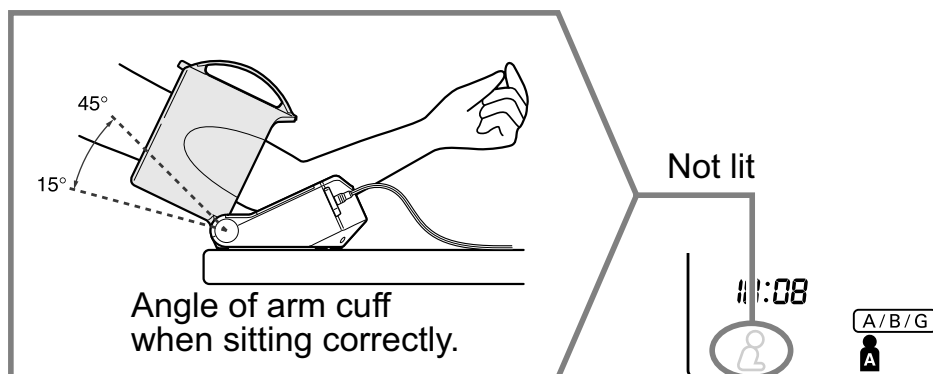

5. Press the START/STOP button once to start measurement. Do not move your arm and remain still until the entire measurement process is completed.

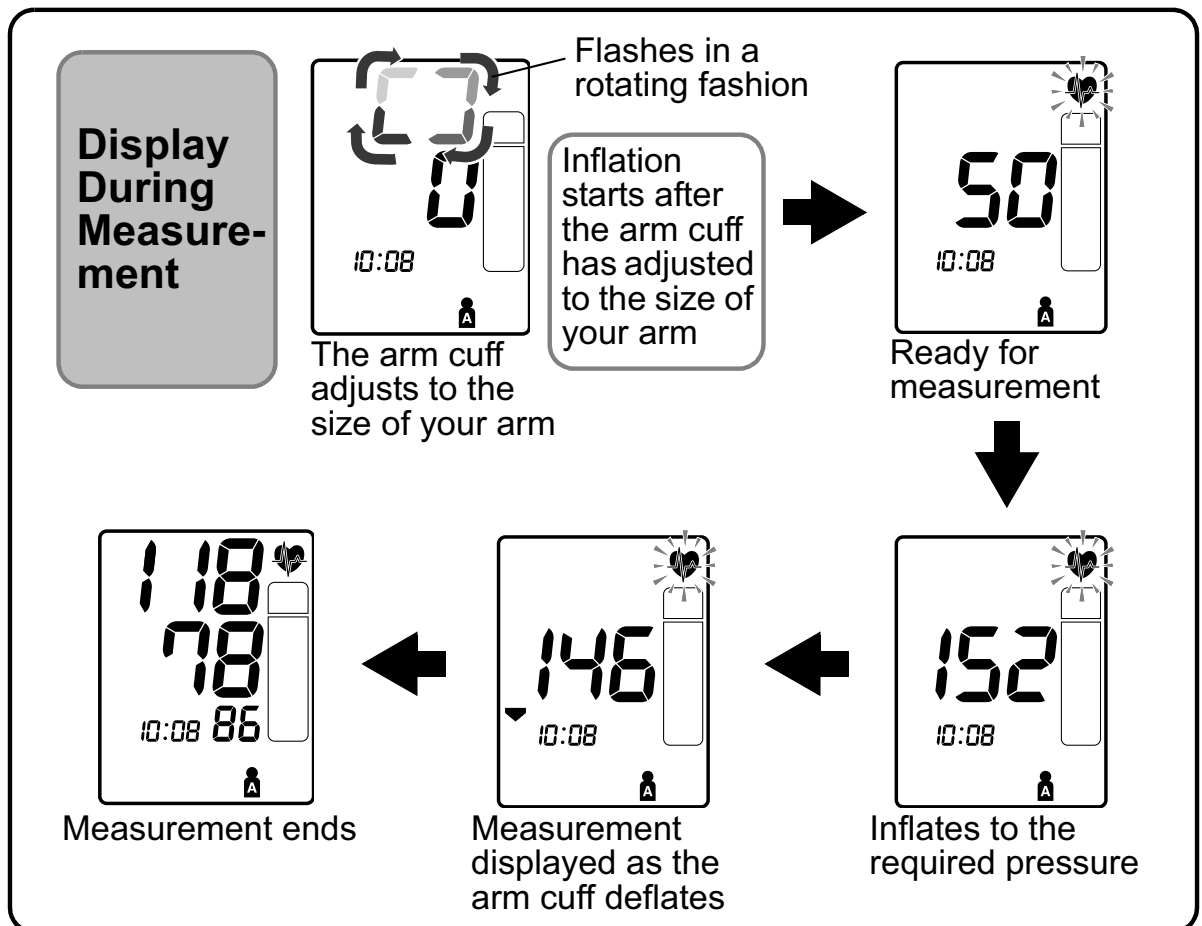
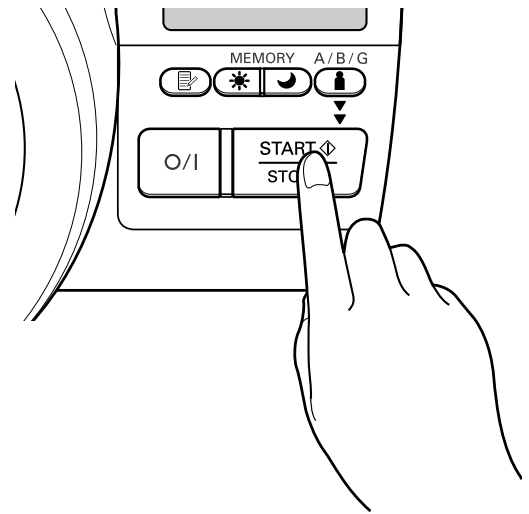

Note: The unit may automatically increase inflation if the arm cuff inflation is insufficient. Automatic re-inflation occurs only once.

To cancel a measurement

If you press the O/I or START/STOP button while the cuff is inflating, measurement stops and the arm cuff deflates.

Note: As a safety measure, measurement will stop if any button is pressed.

Important:

If inflation does not stop when the O/I, START/STOP or any other button is pressed,

Press the emergency deflation switch on the back of the unit.

Note: The clock will also stop if you press the emergency deflation switch. Reset the date and time.

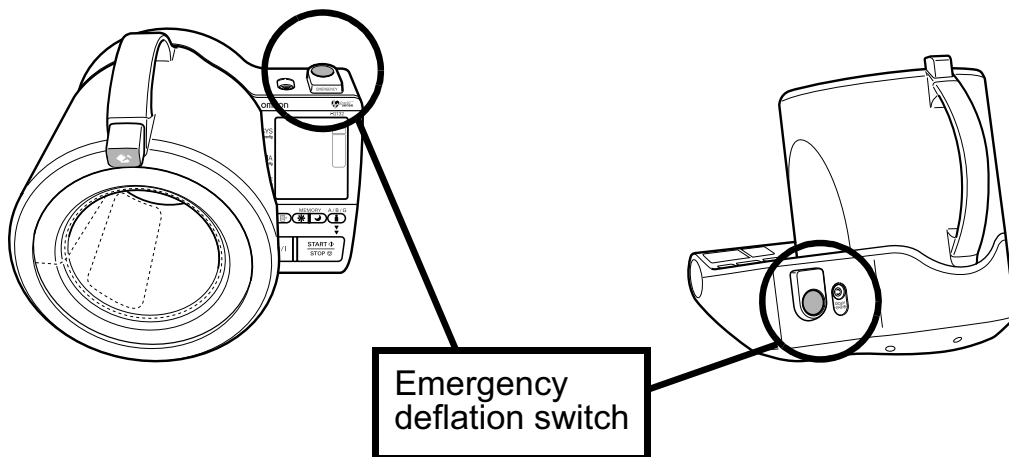

6. Check the measurement results.

The measurement results are automatically stored in the memory. (Refer to Chapter 3.5.)

Note: If “G” (Guest) was selected, the measurement results are not stored in the memory.

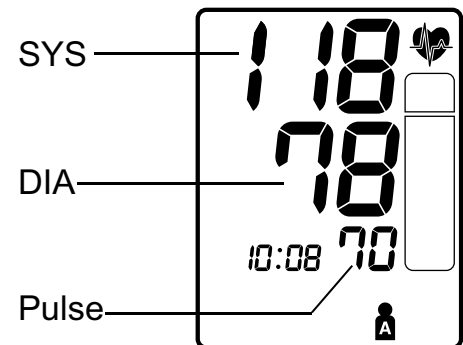

⚠ Warning:
Self-diagnosis of measurement results and self-treatment are dangerous. Always follow the instructions of your doctor.

If the  or  symbols are displayed

Please repeat measurement. In some cases it may not be possible to take measurement correctly.

- **If  displayed**

Incorrect posture during measurement. Sit correctly and take the measurement again. (Refer to Chapter 3.3.4.)

Note: The symbol will disappear in a few seconds, but may appear again depending on the cuff angle at the time.

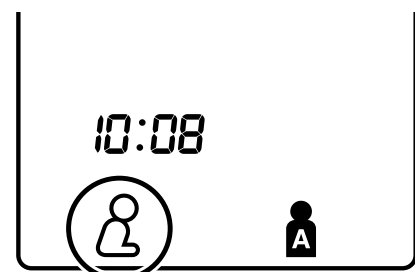

- **If  is displayed**

Movement during measurement. Keep still and repeat the measurement.

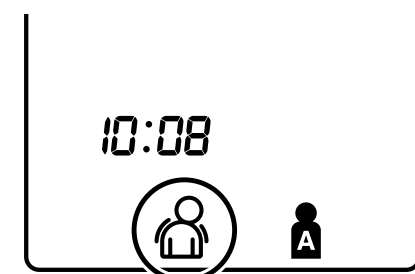

If “E” or “EE” is displayed

Measurement could not be completed successfully. (Refer to Chapter 4.1.)

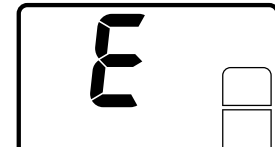

Wait 2-3 minutes before taking another measurement.

Waiting between measurements allows the arteries to return to the condition prior to taking the blood pressure measurement. Repeat the measurement after your arm is relaxed again. (Refer to Chapter 3.3.)

- 7.** Remove your arm and return the arm cuff to its original position.

The arm cuff will click into place.

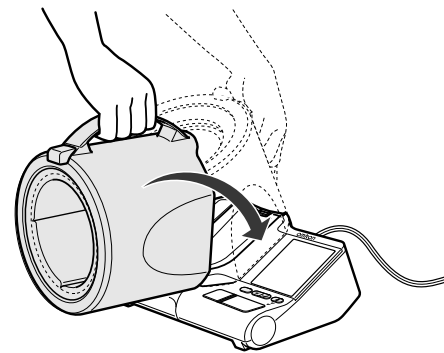

- 8.** Press the O/I button to turn the power off.

Note: If you forget to turn the power off, the unit will turn itself off automatically after five minutes.

Important:

- If your systolic or diastolic pressure is outside the standard range, the heartbeat symbol will blink when the measurement result is displayed.

Recent research suggests that the following values can be used as a guide to high blood pressure for measurements taken at home.

Systolic Blood Pressure	Above 135 mmHg
Diastolic Blood Pressure	Above 85 mmHg

This criteria is for home blood pressure measurement.

For professional office blood pressure measurement criteria, please refer to Chapter 7.

- Your blood pressure monitor includes an irregular heartbeat feature. Irregular heartbeats can influence the results of the measurement. The irregular heartbeat algorithm automatically determines if the measurement is usable or needs to be repeated. If the measurement results are affected by irregular heartbeats but the result is valid, the result is shown together with the irregular heartbeat icon. If the irregular heartbeats cause the measurement to be invalid, no result is shown. If the irregular heartbeat symbol () is shown after you have taken a measurement, repeat the measurement. If the irregular heartbeat symbol is shown frequently, please make your doctor aware of it.

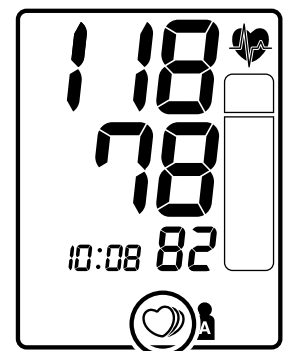
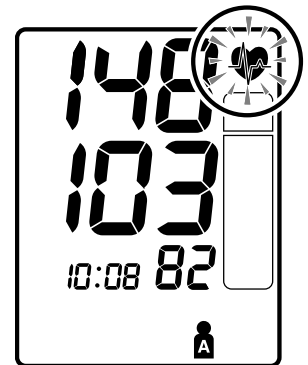

What is Irregular Heartbeat?

An irregular heartbeat is a heartbeat rhythm that varies by more than 25% from the average heartbeat rhythm detected while the unit is measuring the systolic and diastolic blood pressure.

If such an irregular rhythm is detected more than twice

during measurement, the irregular heartbeat symbol () appears on the display with the measurement results.

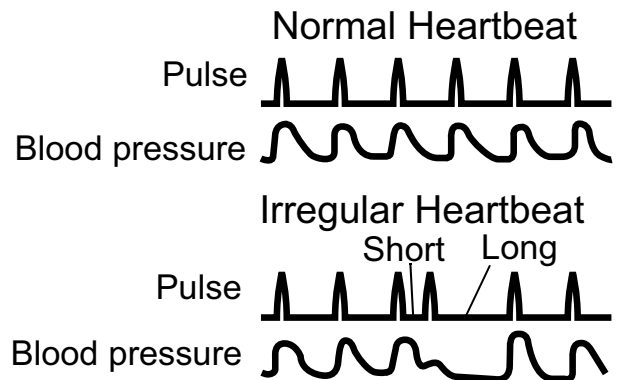

What is Arrhythmia?

A heartbeat is stimulated by electrical signals that cause the heart to contract.

Arrhythmia is a condition where the heartbeat rhythm is abnormal due to flaws in the bio-electrical system that drives the heartbeat. Typical symptoms are skipped heartbeats, premature contraction, an abnormally rapid (tachycardia) or slow (bradycardia) pulse. This can be caused by heart disease, aging, physical predisposition, stress, lack of sleep, fatigue etc. Arrhythmia can only be diagnosed by a doctor through a special examination.

Whether the appearance of the irregular heartbeat symbol () in the results indicates arrhythmia or not can only be determined by an examination and diagnosis by your doctor.

Warning:

If the irregular heartbeat symbol () is shown frequently, please make your doctor aware of it. Conducting self-diagnosis and treatment based on measurement results are dangerous. Be sure to follow the instructions of your doctor.

3.4 Instructions for Special Conditions

If your systolic pressure is known to be more than 170 mmHg or if you failed to measure blood pressure repeatedly, perform the following steps.

1. Place your arm through the arm cuff and press the O/I button to turn the power on.
2. Press the user ID selection button  to select your user ID.

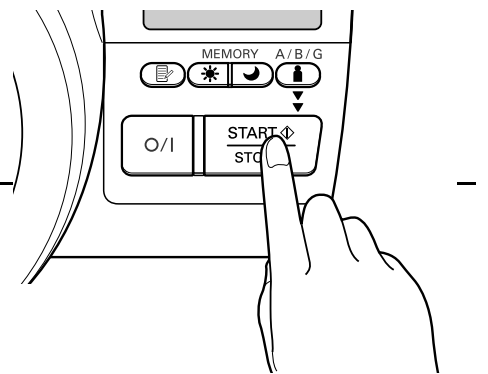

3. Press and hold the START/STOP button until the cuff inflates 30 to 40 mmHg higher than your suspected systolic pressure.

Note: You cannot inflate the cuff above 299 mmHg. (An error will be displayed if you try to inflate the cuff above 299 mmHg.)

4. Release the START/STOP button when the cuff has been inflated to the desired pressure.

The cuff starts to deflate and measurement starts.

5. The rest of the procedure is the same as for normal measurement. Refer to Chapter 3.3.

Note: Do not apply more pressure than necessary.

3.5 Using the Memory Function

The unit is designed to store the blood pressure and the pulse rate in the memory for two people (user A and user B) every time a measurement is completed.

The unit automatically stores up to 84 sets of measurement values (blood pressure and pulse rate) for each user (A and B). When 84 sets of measurement values are stored, the oldest record is deleted to save the most recent values. The unit also stores 8 weeks of morning averages and 8 weeks of evening averages for each user (A and B).

Average Function



The unit calculates the average reading based on the three most recent sets of measurement values taken within 10 minutes of the most recent reading.

Note: If two sets of measurement values are stored in the memory for the 10 minutes period, the average is based on the two sets of measurement values. If one set of measurement values is stored, this is displayed as the average.

To Display the Measurement Values

-
1. Press the O/I button to turn the power on.
 2. Press the user ID selection button  to select the user ID (A or B).

3. Press the MEMORY button .

The average value is shown and the average symbol () appears above the memory symbol () on the display.

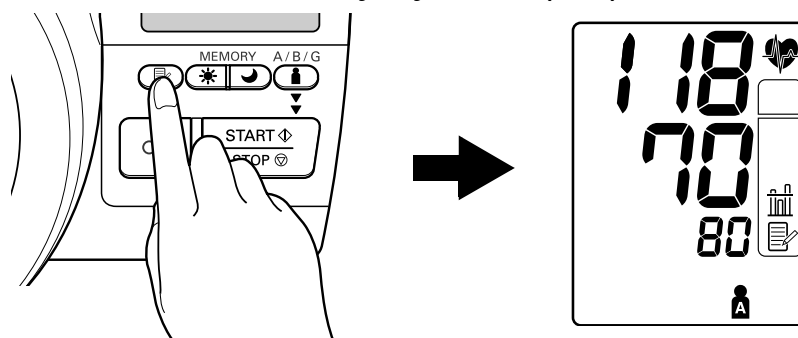

4. Press the MEMORY button  to display the most recent set of individual measurement values on the screen.

Note: After the memory number is shortly indicated, the date and time are alternately displayed with the measurement values.

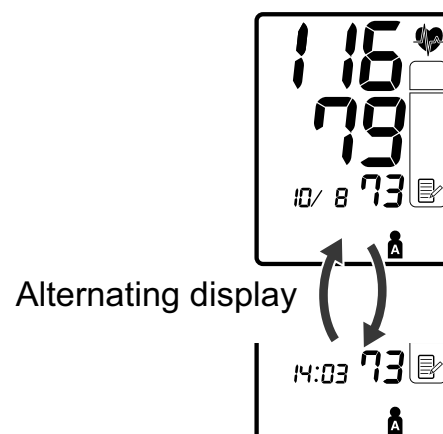

The values are displayed from the most recent to the oldest by pressing the MEMORY button.

Press and hold the MEMORY button to display the values faster.

5. Press the O/I button to turn the unit off.

Morning and Evening Weekly Averages

The unit calculates and displays weekly averages for measurements taken in the morning (☀) and evening (🌙) within 8 weeks for each user (A and B).

Note: The week begins Sunday at 4:00.

About the Weekly Averages

Morning Weekly Average

This is the average for measurements taken during the morning (4:00-9:59) between Sunday and Saturday. An average for each day is calculated for up to three measurements taken within 10 minutes of the first measurement of the morning.

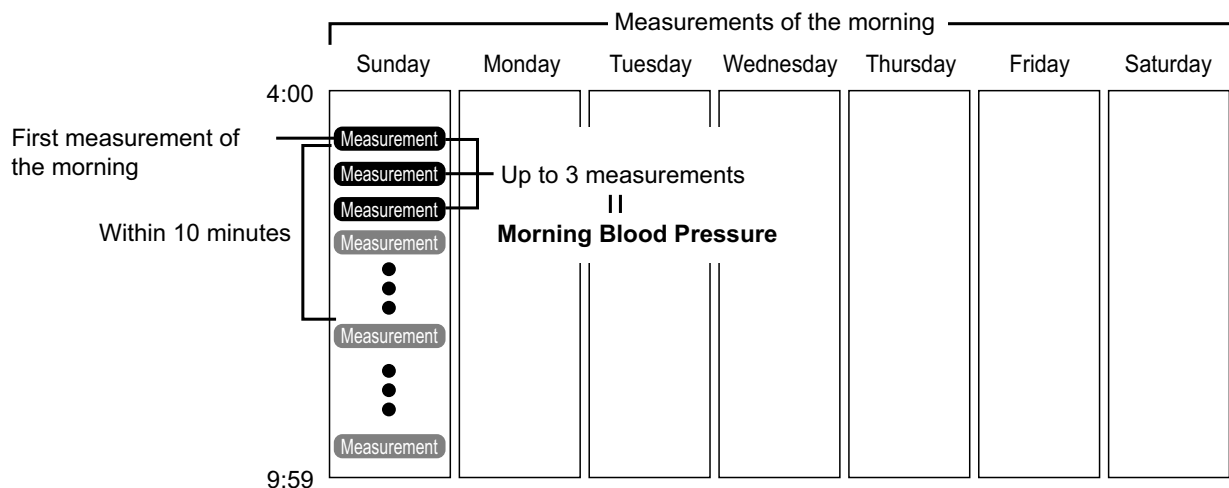



Evening Weekly Average

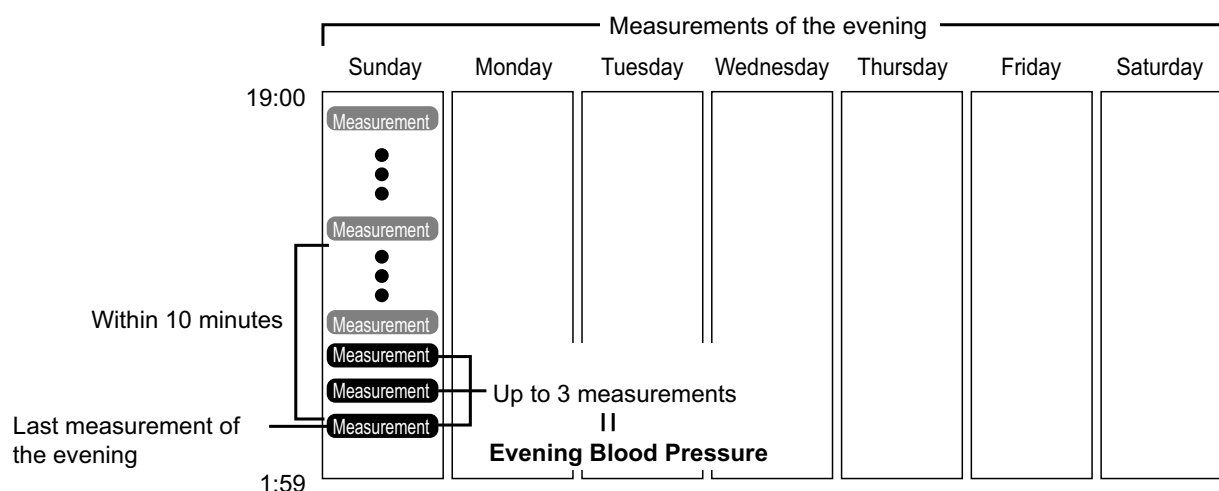

This is the average for measurements taken during the evening (19:00-1:59) between Sunday and Saturday. An average for each day is calculated for up to three measurements taken within 10 minutes of the last measurement of the evening.





To Display Morning and Evening Averages

1. Press the O/I button to turn the power on.
2. Press the user ID selection button  to select the user ID (A or B).
3. Press the morning average button  or the evening average button .

The average for the current week “THIS WEEK” appears on the display.

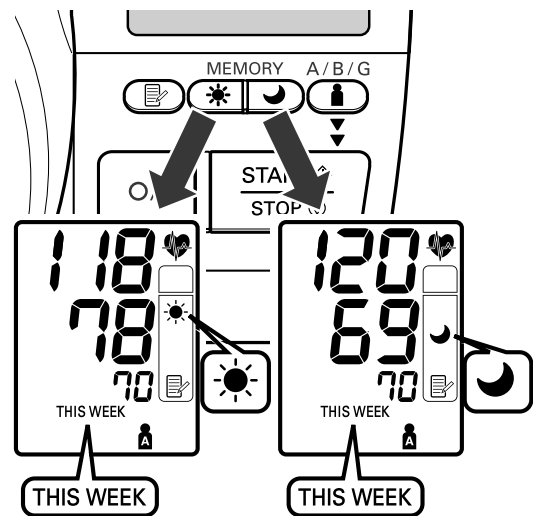
The morning and evening average value of the same week can be displayed by pressing the morning average button  or the evening average button . It is important to check both morning and evening average of the same week.



4. Continue to press the morning average button  or the evening average button  to display the previous weeks. The unit displays “-1 WEEK” for the previous week to “-7 WEEK” for the oldest set of averages.

Note: If there are not enough measurements taken in a week to calculate the average the display will appear as illustrated.

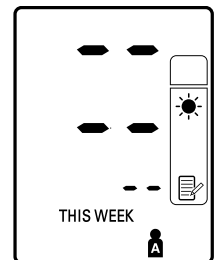

5. Press the O/I button to turn the unit off.

Notes on Display Combinations

In addition to the morning average and evening average symbols, the unit may also display the morning hypertension symbol if the morning average for that week is above the home blood pressure guideline. (See Chapter 3 “Using the Unit - Important information” for details.) Depending on your measurement results, these may be displayed in the following combinations.

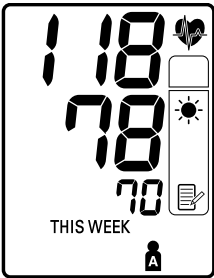
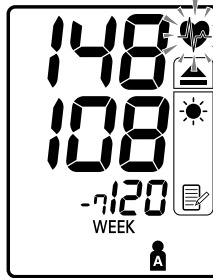
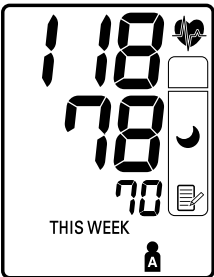
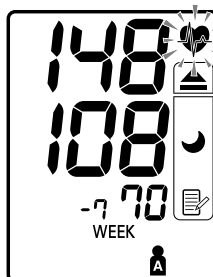
	Display	
Morning Average	 <p>Morning average from This Week with Morning Average Symbol</p>	 <p>Morning average from 7 weeks ago with Morning Average Symbol + blinking heartbeat Symbol + Morning Hypertension Symbol</p>
Evening average	 <p>Evening average from This Week with Evening Average Symbol</p>	 <p>Evening average from 7 weeks ago with Evening Average Symbol + blinking Heartbeat Symbol + Morning Hypertension Symbol</p>
	Average within home blood pressure guideline	Average above home blood pressure guideline + Morning Hypertension

The morning hypertension symbol (▲) appears if the weekly average for morning measurements is above 135/85.

In this case the morning hypertension symbol (▲) is displayed when the evening average is displayed, regardless of the values for the evening average.

To Delete All Values Stored in the Memory

The values stored in the memory are deleted by user ID.

You cannot partially delete values stored in the memory. All values for the user you select will be deleted.

1. Press the O/I button to turn the power on.
2. Press the user ID selection button (👤) to select the user ID (A or B).
3. While holding the MEMORY button (📄) press the START/STOP button simultaneously for more than 2 seconds and all values will be deleted.

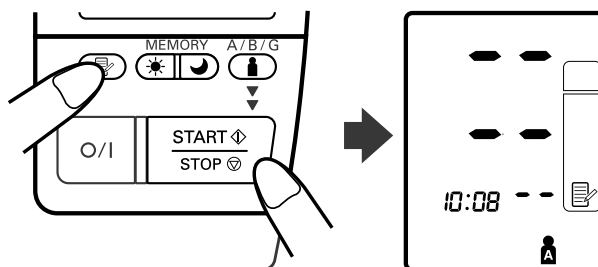

4. Handling Errors and Problems

4.1 Error Messages

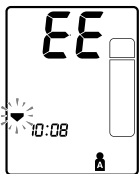
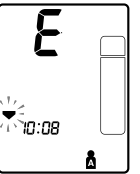
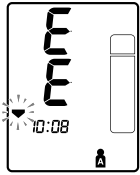
Error Display	Cause	Remedy
 <p>EE displayed in the systolic pressure area.</p>	Movement during measurement	<p>Check that the heartbeat symbol is lit, then keep still and repeat measurement. (Refer to Chapter 3.3)</p> <p>If the EE appears again, use again, refer to Chapter 3.4.</p>
 <p>E displayed in the systolic pressure area.</p>	Is the arm placed through the arm cuff correctly?	Place your arm correctly. (Refer to Chapter 3.2)
	Are rolled up sleeves squeezing the arm?	Remove clothing from your upper arm and place your arm through the cuff. (Refer to Chapter 3.2)
	Is air leaking from the arm cuff?	Contact your OMRON distributor or Customer Services as mentioned on the package.
	Movement during measurement	Check that the heartbeat symbol is lit, then keep still and repeat measurement.
 <p>EE displayed.</p>	Arm cuff has been inflated above 299 mmHg.	<p>Do not inflate the arm cuff above 299 mmHg. (Refer to Chapter 3.4)</p>

Note: If you change your posture, or move, during measurement, the posture symbol (🧑) or movement symbol (🧑) may be displayed during measurement.

4. Handling Errors and Problems

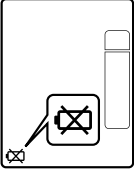
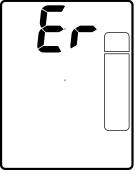
Error Display	Cause	Remedy
 <p>Battery low symbol blinks or appears continuously.</p>	Batteries have run down.	Replace all four “AA” batteries with new ones. (Refer to Chapter 2.1)
 <p>Er displayed.</p>	A malfunction has occurred.	Contact your OMRON distributor or Customer Services as mentioned on the package.

4.2 Troubleshooting

Problem	Cause	Remedy
The reading is extremely high (or low).	Is your arm placed through the arm cuff correctly?	Refer to Chapter 3.2.
	Talking during the measurement.	Keep quiet during measurement. Carefully read and repeat the steps listed under Chapter 3.3.
	Are rolled up sleeves squeezing the arm?	Carefully read and repeat the steps listed under Chapter 3.3.
	Is the cuff lining in the arm cuff damaged?	Cancel the measurement and contact your OMRON distributor or Customer Services.
Cuff is not inflated.	Is air leaking from the arm cuff?	Contact your OMRON distributor or Customer Services.
The unit operates normally and measurements appear to be taken, but... <ul style="list-style-type: none"> • Measurements taken by a doctor are higher (or lower). • Measurement results are different each time. 		Refer to Chapter 7.
Power is turned off during measurement. The date and time are reset.	The batteries are empty.	Replace the batteries. (Refer to Chapter 2.1.)
The backlight does not light.	The AC adapter is not connected.	The backlight does not light when using only the batteries. Connect the AC adapter. (Refer to Chapter 2.2.)

4. Handling Errors and Problems

Problem	Cause	Remedy
<p>The date and time flash, even though the date and time have been set, after the batteries are replaced.</p>	<p>The emergency deflation switch was pressed.</p>	<p>Set the date and time again. (Refer to Chapter 2.3.) Even if the power is turned off, the clock will also stop if you press the emergency deflation switch. Take care not to press the emergency deflation switch when cleaning or moving the unit.</p>
	<p>Have the batteries been removed?</p>	<p>Set the date and time again. (Refer to Chapter 2.3.) The date and time will be reset if the batteries are removed for more than 30 seconds. Replace the batteries within 30 seconds.</p>
<p>No display appears when O/I button is pressed.</p>	<p>The batteries are empty.</p>	<p>Replace the batteries. (Refer to Chapter 2.1.)</p>
	<p>The batteries are installed incorrectly.</p>	<p>Insert the batteries correctly. (Refer to Chapter 2.1.)</p>
	<p>The AC adapter was disconnected from the unit when using the AC adapter only.</p>	<p>Connect the AC adapter. (Refer to Chapter 2.2.)</p>
	<p>The AC adapter was disconnected from the power supply when using the AC adapter only.</p>	<p>Connect the AC adapter to the power supply. (Refer to Chapter 2.2.)</p>
<p>Readings are not stored in the memory.</p>	<p>G (guest) was selected, or no user ID was selected.</p>	<p>Select the correct user ID. (Refer to Chapter 3.3.)</p>

Problem	Cause	Remedy
Other.		Turn the power off, then repeat measurement. Replace the batteries. If the problem persists, contact your OMRON distributor or Customer Services as mentioned on the package.

5. Maintenance and Storage

To protect your unit from damage, please observe the following:

- Do not subject the unit to extreme temperatures, humidity, moisture or direct sunlight.
- Do not carry out repairs of any kind yourself. If a defect occurs, consult the OMRON distributor or Customer Services as mentioned on the package, or seek the advice of your surgical appliance stockist or pharmacist.
- The OMRON i-Q132 is a precision measuring device. It is important that the accuracy remains within the specifications. It is recommended that you have the unit inspected every two years to ensure it is accurate and functioning correctly. Consult the OMRON distributor or Customer Services as mentioned on the package for further details.
- Do not subject the unit to strong shocks or vibrations (for example, dropping the unit on the floor.)
- Do not use volatile liquids to clean the unit. **THE UNIT AND THE CUFF SHOULD BE CLEANED WITH A SOFT, DRY CLOTH.** To remove stubborn stains, wipe the unit with a damp cloth moistened with mild detergent.
- Do not splash water on the unit or allow liquids to get inside the unit.
- Do not remove the cuff lining in the arm cuff.
- Do not wash or moisten the cuff lining.

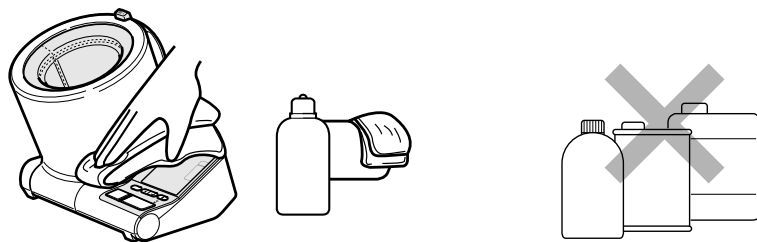

Storage

Please observe the following storage conditions.

- Do not subject the unit to extreme temperatures, humidity, moisture, or direct sunlight.
- Do not subject the unit to strong shocks or vibrations, or leave it at an angle.
- Do not store the unit where it will be exposed to chemical or corrosive vapours.

Storage Precautions

- Store the unit with the arm cuff closed.
- Remove the batteries if the unit will not be used for a long time (3 months or longer).
- When the unit is not in use, or if it is moved etc., do not place objects (writing implements, note books, the AC adapter etc.) in the cuff. This could cause damage to the cuff lining or the main unit and prevent the unit from taking correct readings.

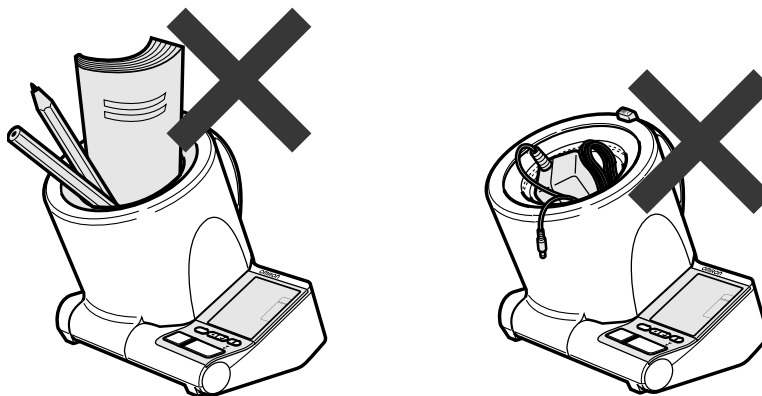

6. Technical Data

Product Description	Digital Automatic Blood Pressure Monitor
Model	OMRON i-Q132 (HEM-1010-E)
Display	LCD Digital Display
Measurement Method	Oscillometric method
Measurement Range	Pressure: 0 mmHg to 299 mmHg Pulse: 40 to 180/min.
Accuracy	Pressure: ± 3 mmHg Pulse: $\pm 5\%$ of display reading
Inflation	Fuzzy-logic controlled by electric pump
Deflation	Automatic pressure release valve
Pressure Detection	Capacitive pressure sensor
Memory	84 Measurements with date and time for each user (A and B)
Power Source	4 "AA" alkaline batteries 1.5V or AC/DC adapter (Included; Input 100-240V 50Hz/60Hz, Output 6V/6W)
Battery Life	Approx. 250 measurements when used 6 times a day with 4 new alkaline batteries without AC adapter
Operating temperature/ Humidity	10°C to 40°C/30 to 85% RH
Storage temperature/ Humidity/Air Pressure	-20°C to 60°C/10 to 95% RH 700 - 1060 hPa
Console Weight	Approximately 1600g without batteries
Outer Dimensions	Approximately 228 (l) mm \times 230 (w) mm \times 217 (h) mm
Arm Circumference	17 to 32 cm
Package Content	Instruction manual, quick guide, AC adapter, battery set, guarantee card, blood pressure pass

Note: Subject to technical modification without prior notice.

- This OMRON product is produced under the strict quality system of OMRON Healthcare Co. Ltd., Japan. The Core component for OMRON blood pressure monitors, which is the Pressure Sensor, is produced in Japan for assembly.

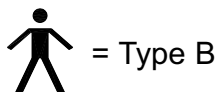

CE 0197

- This device fulfils the provisions of EC directive 93/42/EEC (Medical Device Directive).
- This blood pressure monitor is designed according to the European Standard EN1060, Non-invasive sphygmomanometers Part 1: General Requirements and Part 3: Supplementary requirements for electromechanical blood pressure measuring systems.

Important information regarding Electro Magnetic Compatibility (EMC)

With the increased number of electronic devices such as PC's and mobile (cellular) telephones, medical devices in use may be susceptible to electromagnetic interference from other devices. Electromagnetic interference may result in incorrect operation of the medical device and create a potentially unsafe situation. Medical devices should also not interfere with other devices.

In order to regulate the requirements for EMC (Electro Magnetic Compatibility) with the aim to prevent unsafe product situations, the EN60601-1-2 standard has been implemented. This standard defines the levels of immunity to electromagnetic interferences as well as maximum levels of electromagnetic emissions for medical devices.

This medical device manufactured by OMRON Healthcare conforms to this EN60601-1-2:2001 standard for both immunity and emissions.

Nevertheless, special precautions need to be observed:

- Do not use mobile (cellular) telephones and other devices, which generate strong electrical or electromagnetic fields, near the medical device. This may result in incorrect operation of the unit and create a potentially unsafe situation. Recommendation is to keep a minimum distance of 7 m. Verify correct operation of the device in case the distance is shorter.

Further documentation in accordance with EN60601-1-2:2001 is available at OMRON Healthcare Europe at the address mentioned in this instruction manual. Documentation is also available at www.omron-healthcare.com.

Correct Disposal of This Product (Waste Electrical & Electronic Equipment)

This marking shown on the product or its literature, indicates that it should not be disposed of, with other household wastes at the end of its working life. To prevent possible harm to the environment or human health from uncontrolled waste disposal, please separate this from other types of wastes and recycle it responsibly to promote the sustainable reuse of material resources.



Household users should contact either the retailer where they purchased this product, or their local government office, for details of where and how they can take this item for environmentally safe recycling.

Business users should contact their supplier and check the terms and conditions of the purchase contract. This product should not be mixed with other commercial wastes for disposal.

This product does not contain any hazardous substances.

7. Some Useful Information about Blood Pressure

What is Blood Pressure?

Blood pressure is a measure of the force of blood flowing against the walls of the arteries. Arterial blood pressure is constantly changing during the course of the heart's cycle.

The highest pressure in the cycle is called the *Systolic Blood Pressure*; the lowest is the *Diastolic Blood Pressure*.

Both pressure readings, the *Systolic* and *Diastolic*, are necessary to enable a doctor to evaluate the status of a patient's blood pressure.

Why is it a Good Thing to measure Blood Pressure at Home?

Having your blood pressure measured by a doctor can cause anxiety which is itself a cause of high blood pressure. As a variety of conditions affect blood pressure, a single measurement may not be sufficient for an accurate diagnosis.

Many factors such as physical activity, anxiety, or the time of day, can influence your blood pressure. Thus it is best to try and measure your blood pressure at the same time each day, to get an accurate indication of any changes in blood pressure. Blood pressure is typically low in the morning and increases from afternoon to evening. It is lower in the summer and higher in the winter.

Blood pressure is measured in millimetres of mercury (mmHg) and measurements are written with the systolic pressure before the diastolic e.g. A blood pressure written as 140/90, is referred to as 140 over 90 mmHg.

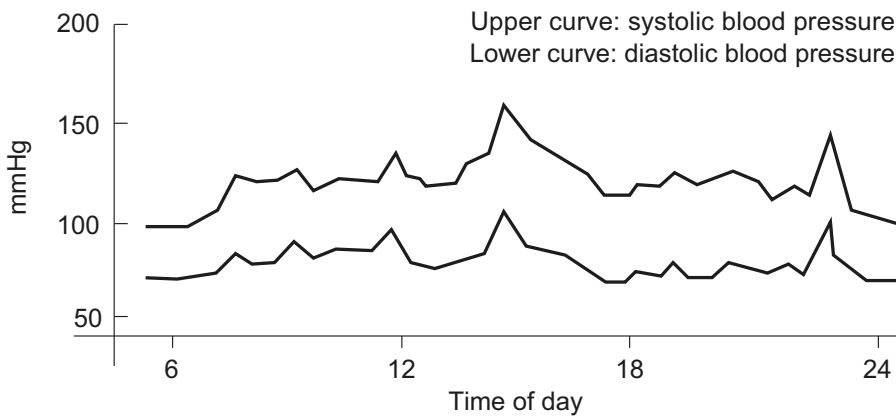

Example: fluctuation within a day (male, 35 years old)

Classification of Blood Pressure by the World Health Organization

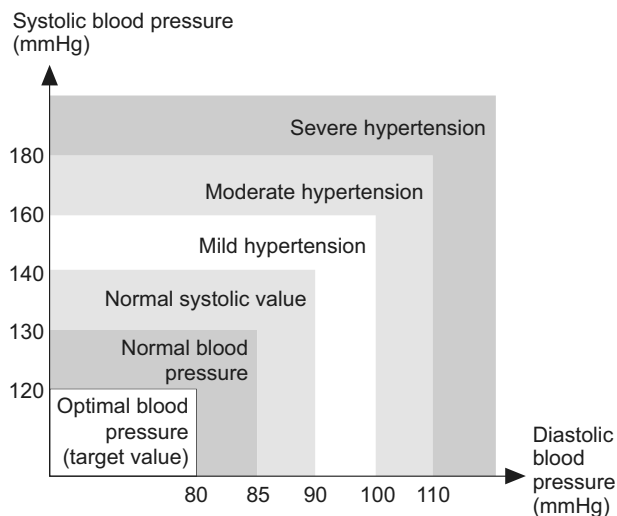

The World Health Organization (WHO) and the International Society of Hypertension (ISH) developed the Blood Pressure Classification shown in this figure.



This classification is based on the blood pressure values measured on people in a sitting position in outpatient departments of hospitals.

Note: There is no universally accepted definition of hypotension. However, those having the systolic pressure below 100 mmHg are assumed as hypotensive.

7. Some Useful Information about Blood Pressure

Manufacturer 	OMRON HEALTHCARE Co., Ltd. 53, Kunotsubo, Terado-cho, Muko, Kyoto, 617-0002 JAPAN
EU-representative 	OMRON HEALTHCARE EUROPE B.V. Scorpius 33, 2132 LR Hoofddorp, THE NETHERLANDS www.omron-healthcare.com
Production facility	OMRON (DALIAN) CO., LTD. Dalian, CHINA
Subsidiary	OMRON HEALTHCARE UK LTD. Opal Drive, Fox Milne, Milton Keynes, MK15 0DG, U.K.
	OMRON MEDIZINTECHNIK HANDELSGESELLSCHAFT mbH John-Deere-Str. 81a, 68163 Mannheim, GERMANY www.omron-medizintechnik.de
	OMRON SANTÉ FRANCE SAS 14, rue de Lisbonne, 93561 Rosny-sous-Bois Cedex, FRANCE

Made in China